



**AÇO METAIS**<sup>®</sup>  
ALUMÍNIO E COMPONENTES

**PELE DE VIDRO**

**EDIÇÃO  
2020**

**AFC-233**

20,700 Kg/br

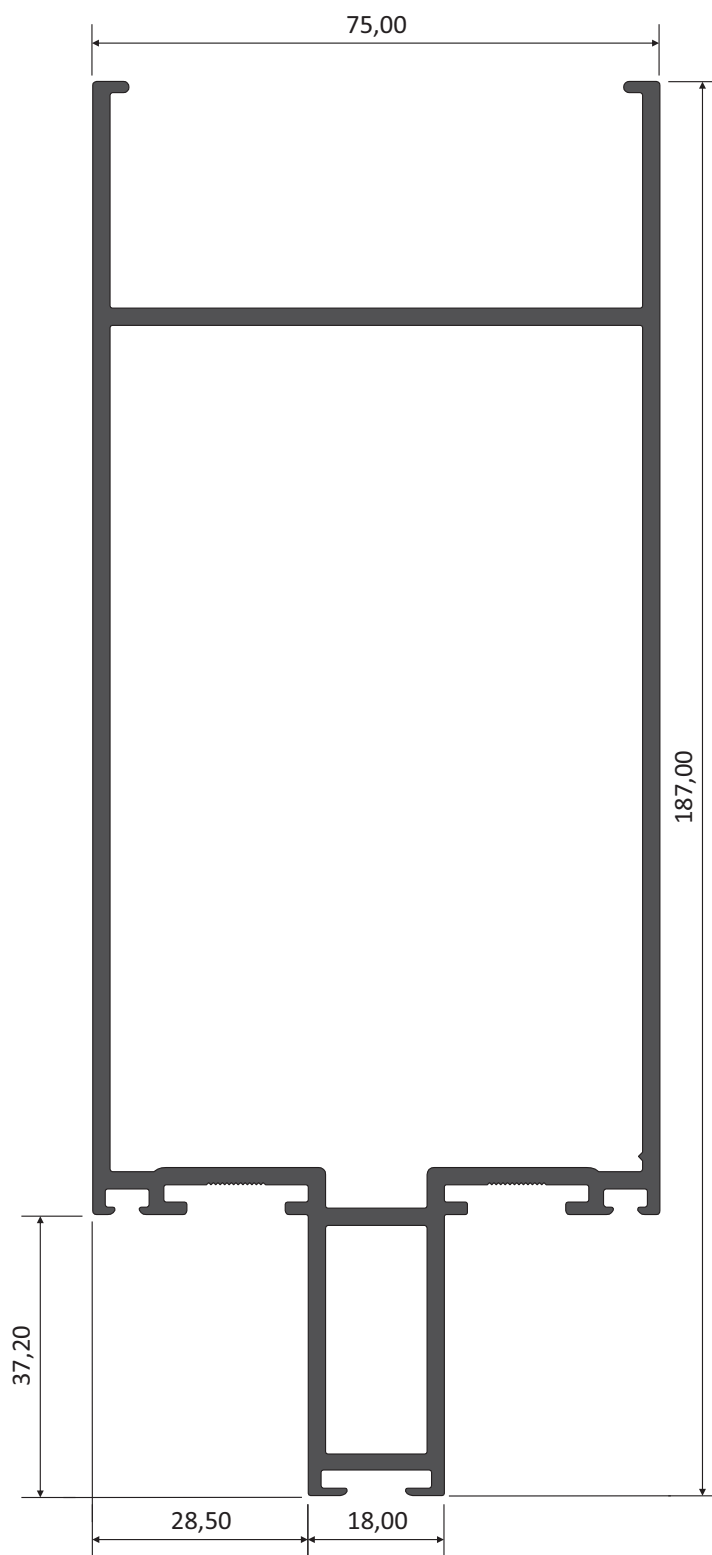

**AFC-202**

10,400 Kg/br

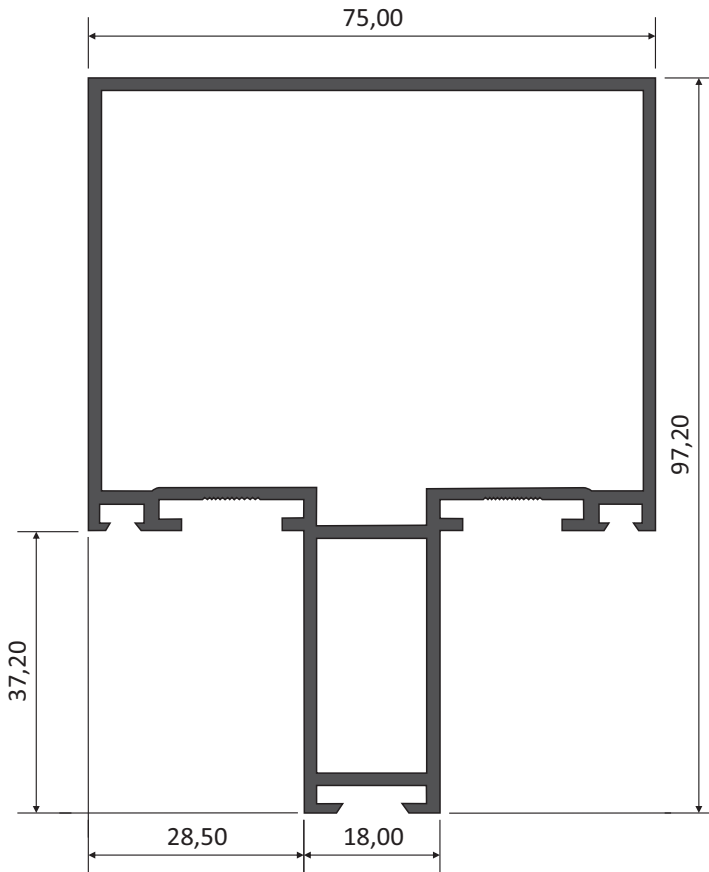

**AFC-225**

3,840 Kg/br

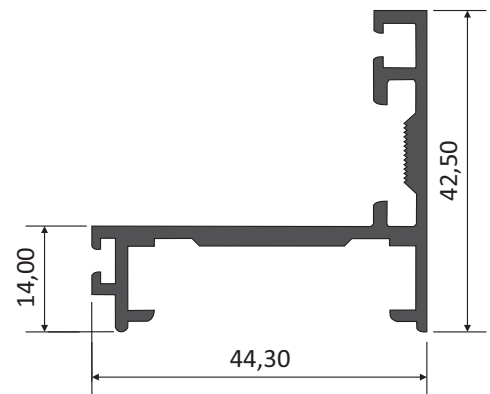

**AFC-243**

5,850 Kg/br

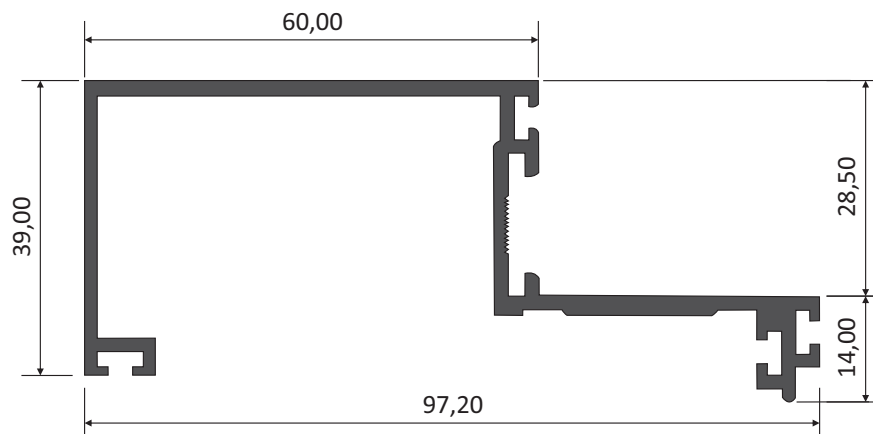

**AFC-244**

10,720 Kg/br

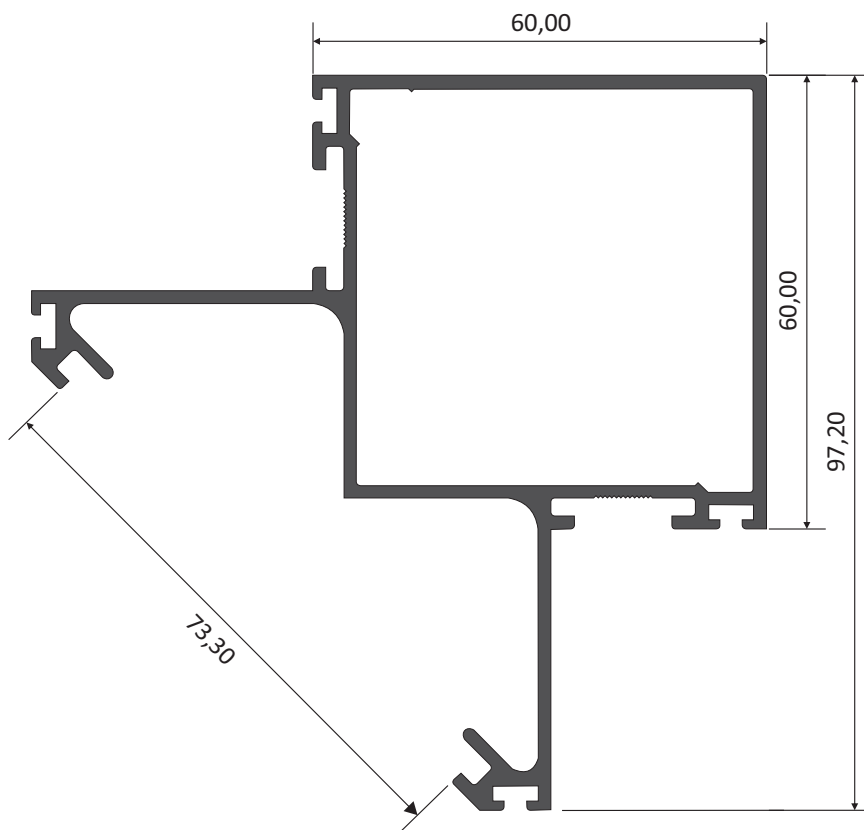

**AFC-242**

4,750 Kg/br

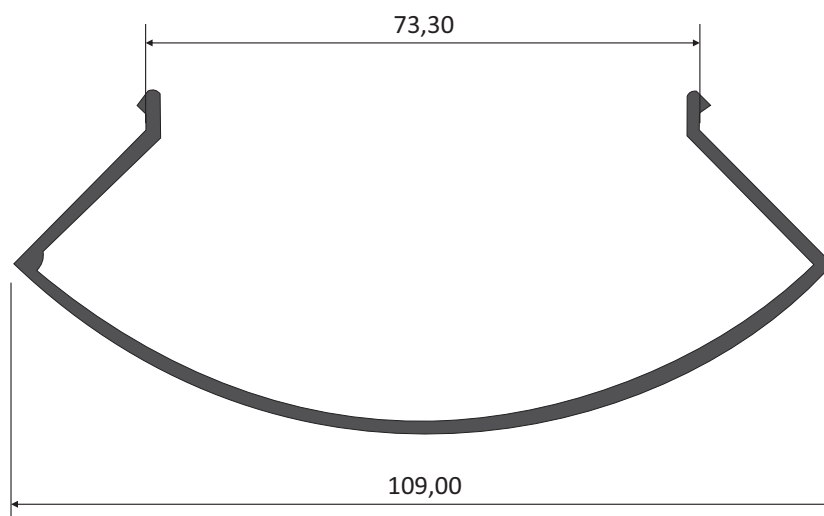

**AFC-231**

6,380 Kg/br

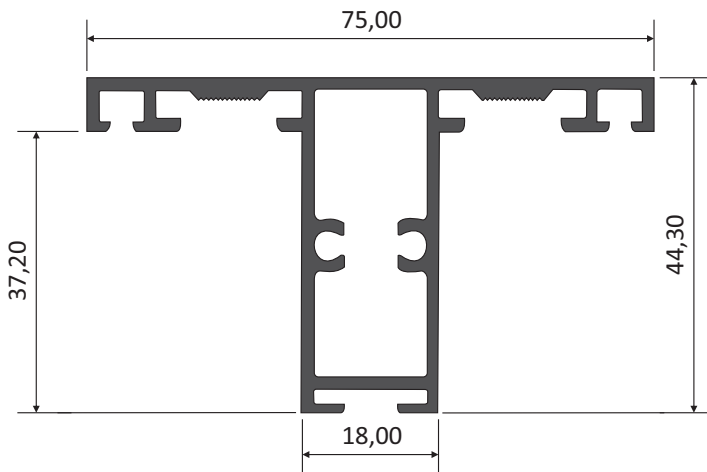

**AFC-261**

3,330 Kg/br

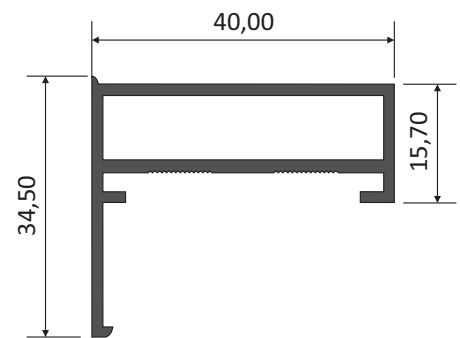

**AFC-226**

4,500 Kg/br

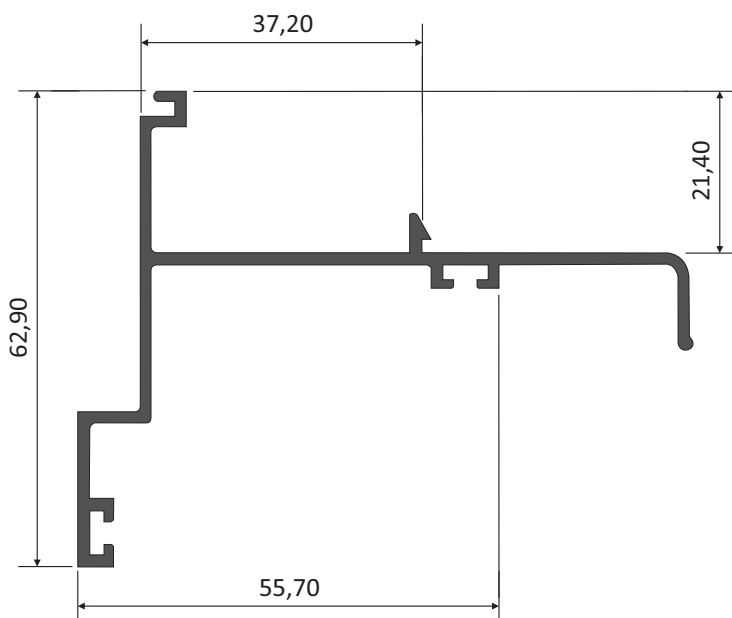

**AFC-228**

3,580 Kg/br

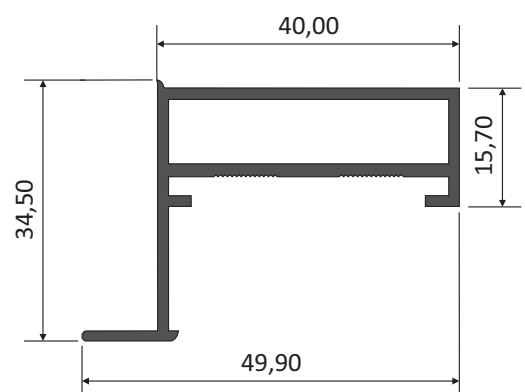

**AFC-227**

4,050 Kg/br

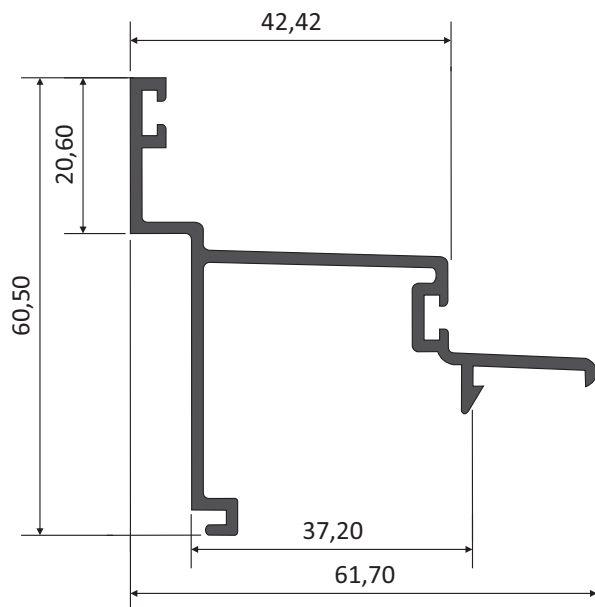

**AFC-249**

3,630 Kg/br

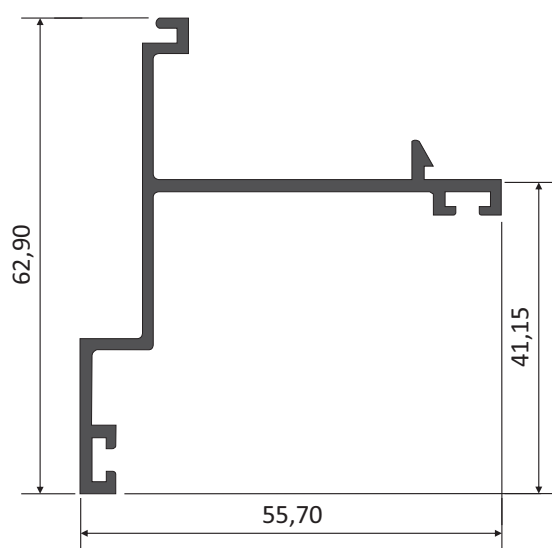

**AFC-245**

5,000 Kg/br

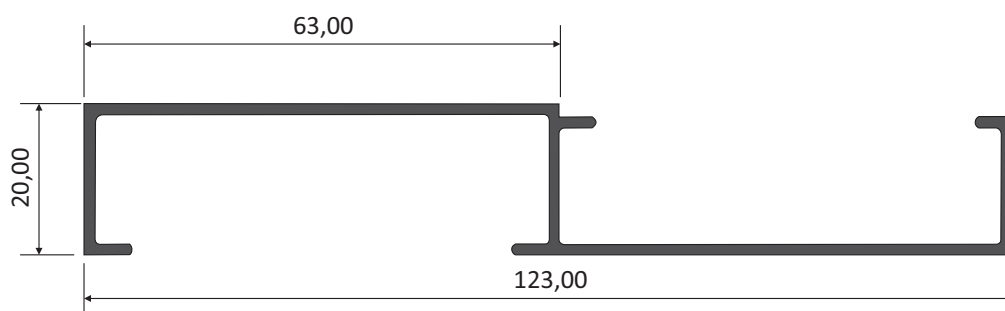

**AFC-085**

1,620 Kg/br

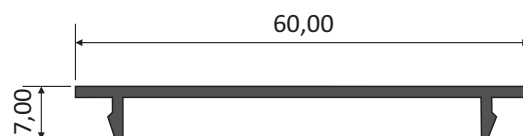

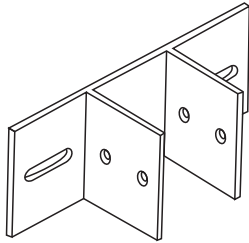

ANC-951

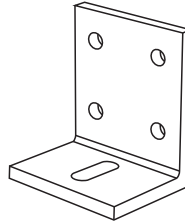

ANC-964

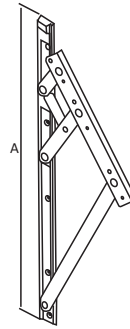

Braço

BRA-588 35 cm	BRA-589 60 cm
BRA-590 95 cm	BRA-591 120 cm

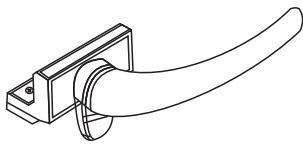

FEC-152



GUA-160

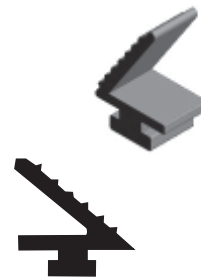

GUA-161



GUA-162

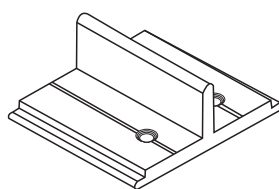

PRE-950

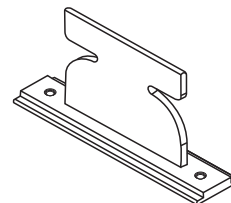

PRE-951